



THERMOLEV® ECO S.A.T.E.

**The Advanced Thermal Mortar for
Sustainable Insulation and Protection**

BUILDING FOR PERFORMANCE, DURABILITY, AND COMFORT

Today's building envelopes must do more than ever before. They must meet stringent demands for:

	Energy Efficiency: Eliminating thermal bridges to reduce long-term operational costs and meet environmental standards.
	Durability & Health: Combating moisture ingress, preventing rising damp, and ensuring the longevity of the structure.
	Comfort & Wellbeing: Creating acoustically insulated interiors, free from ambient noise.
	Sustainability: Utilizing materials with high recycled content and a low environmental footprint.

AN INTEGRATED SOLUTION FOR THE BUILDING ENVELOPE

Thermolev ECO is a high-performance, lime-based thermal mortar designed to provide a seamless, multi-functional layer of insulation and protection for both new builds and restorations. It is an external and internal thermal insulation system (SATE / ETICS).

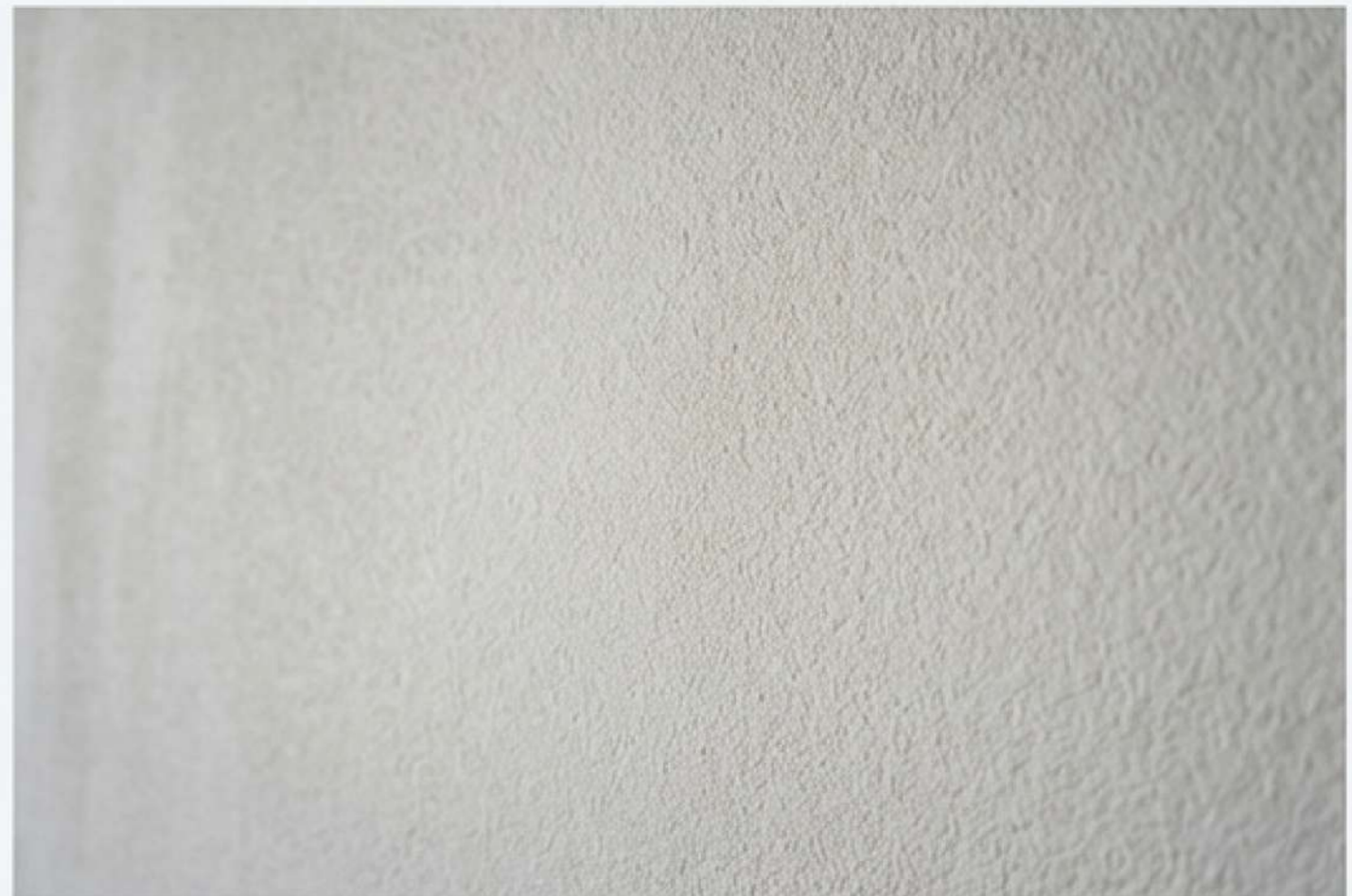

ENGINEERED WITH NATURAL TECHNOLOGY

The superior performance of Thermolev ECO stems from its innovative, sustainable formula:

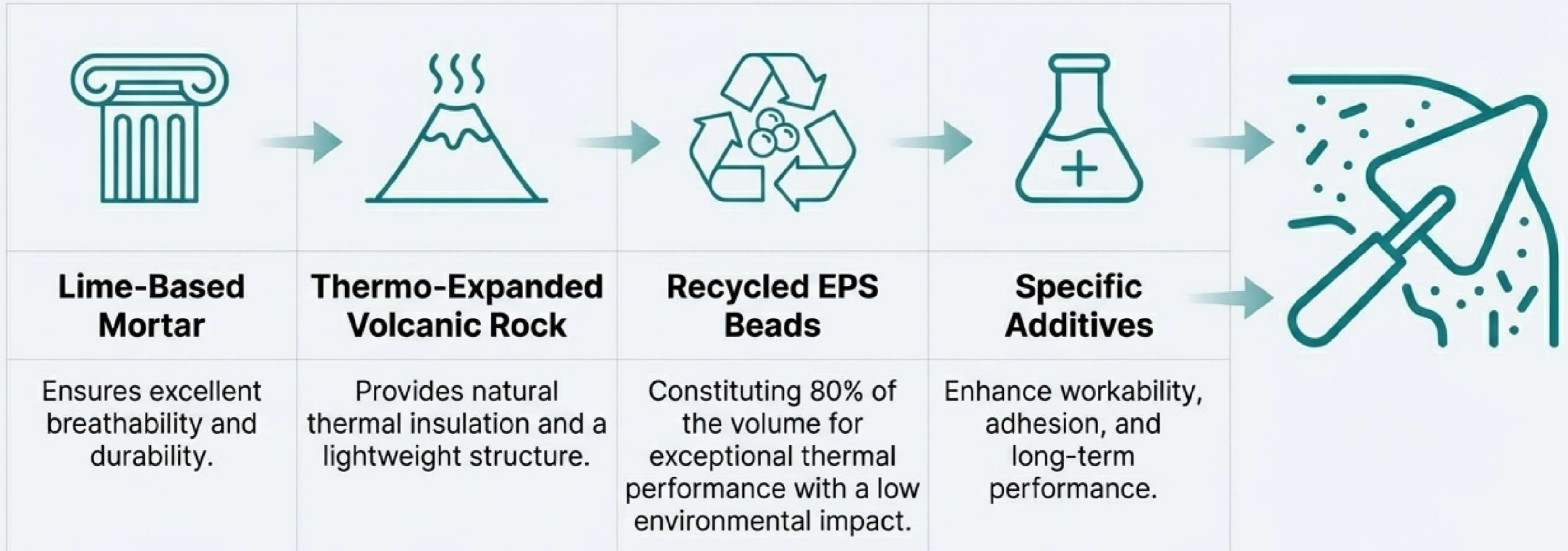

ONE PRODUCT, COMPREHENSIVE PERFORMANCE



Superior Thermal Insulation:

Creates a seamless layer, eliminating thermal bridges.



Effective Acoustic Insulation:

Improves room acoustics by reducing ambient noise.



Advanced Moisture Control:

Water-repellent and breathable; actively remediates rising damp.

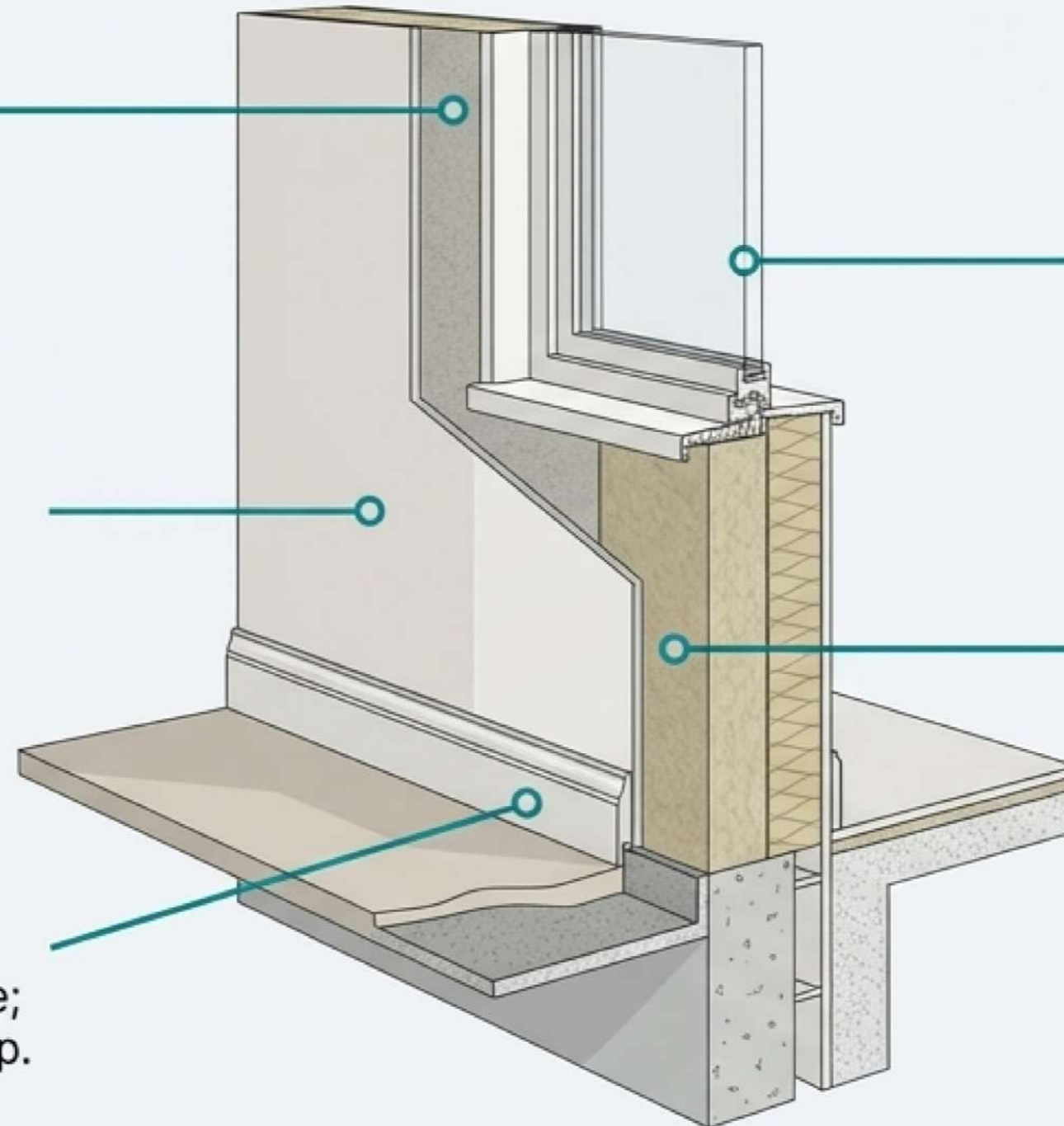

Exceptional Durability: High resistance to weathering and the passage of time.



Eco-Friendly: Non-toxic, biodegradable, and features a high recycled content.

EXCEPTIONAL THERMAL THERMAL EFFICIENCY, QUANTIFIED

0.05 W/m·K

According to EN 12667

Thermolev ECO's low thermal conductivity creates a continuous insulating envelope, drastically improving a building's energy performance and preventing costly thermal bridges.



BUILT FOR LONGEVITY AND SAFETY



Fire Safety

**Fire Resistance:
Class B-s1, d0**

Minimizes the risk of flame spread, contributing to safer building design.



Moisture Protection

**Capillarity: W 2
(EN 1015-18)**

Indicates excellent resistance to water absorption, protecting the substrate from moisture damage.

THE IDEAL SOLUTION FOR A RANGE OF APPLICATIONS

- Façades in new construction and restorations.
- Interior walls and ceilings requiring thermal and acoustic performance.
- Remediation of baseboards and plinths with rising damp.
- Leveling of imperfect or irregular substrates.
- Sustainable projects with demanding energy efficiency requirements.



1 APPLICATION SYSTEM — STEP 1: SUBSTRATE PREPARATION

SUITABLE SUBSTRATES

Masonry, brick, cement, concrete, concrete blocks, and other mineral-origin surfaces with a lime or cement base.

SURFACE REQUIREMENTS

- ✓ Firm
- ✓ Clean
- ✓ Compact
- ✓ Free of loose particles or contaminants

PRE-TREATMENT

It is recommended to thoroughly moisten the surface with clean water before application to ensure optimal adhesion.



2 APPLICATION SYSTEM — STEP 2: MIXING AND APPLYING THERMOLEV ECO



MIXING

Thoroughly mix one 50 L bag with 15–18 L of clean water using a mechanical mixer until a dense, homogeneous paste is achieved.

APPLICATION

Apply manually with a plastic trowel or mechanically with specialized plastering machines. Maximum thickness of 3-4 cm per layer.

ADHESION LAYER (OPTIONAL BUT RECOMMENDED)

For enhanced adhesion, an initial slurry (Thermolev ECO with 30 L of water per bag) can be applied to fill pores.

3 APPLICATION SYSTEM — STEP 3: REINFORCEMENT AND FINISHING

LEVELING

Once applied, level the Thermolev ECO surface.

REINFORCEMENT

After the surface is moistened, apply two layers of **FLEXILEV** fiber-reinforced mortar, approximately 2 mm each.

MESH INTEGRATION

Embed a 160g/m² mesh between the two layers of FLEXILEV.

RESULT

A smooth, durable, and crack-resistant surface ready for the final decorative finish.

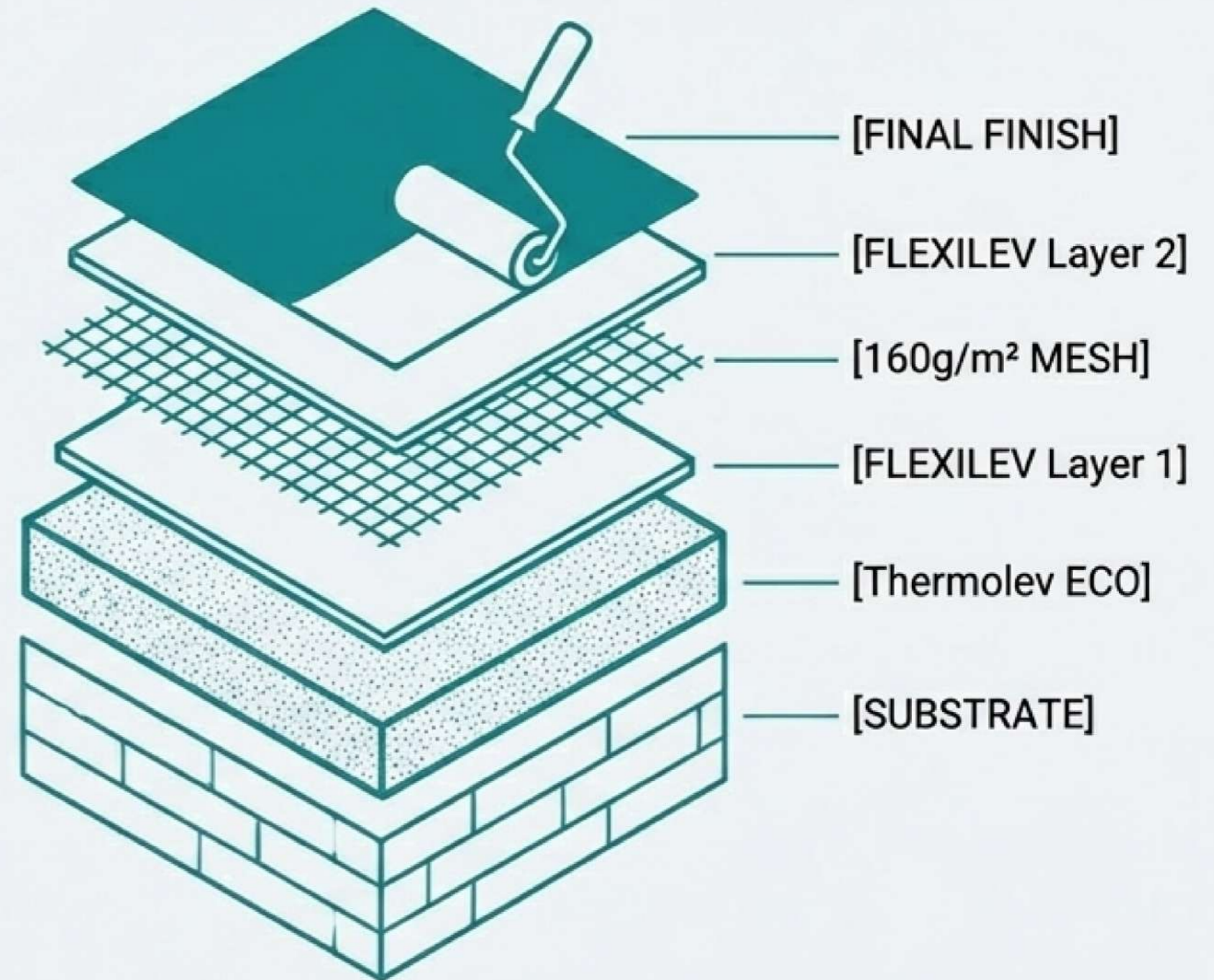

TECHNICAL SPECIFICATIONS: Thermolev® ECO S.A.T.E.

Property	Value & Standard
Thermal Conductivity	0.05 W/m·K (EN 12667)
Density	220 kg/m³ ± 20 (EN 1015-10)
Compressive Strength	0.85 N/mm² (EN 1015-11)
Mechanical Bending Strength	0.50 N/mm ² (EN 1015-11)
Capillarity	W 2 (EN 1015-18)
Fire Resistance	Class B-s1, d0
Consumption	2 - 2.5 kg/m ² per cm of thickness
Drying Time	Approx. 1.5 cm per day
Grain Size	≤ 1.5 – 2.5 mm

 Standard: EN 998-1

PACKAGING, STORAGE, AND HANDLING

Packaging

Supplied in 50 L bags (approx. 11 kg).

Storage & Shelf Life

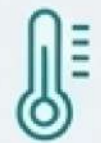

Store in its original sealed container in a cool place (5–45°C), protected from direct sun, frost, and moisture.



Shelf Life: Up to 3 years from the date of manufacture.

Usage

For professional use only. Follow all safety guidelines.

Application temperature: 5–35°C.

Do not apply in adverse weather conditions (risk of frost, direct sun, strong wind, or rain).



Help Us Help You

Innovation in Protection.



The information provided is based on extensive practical experience and laboratory testing.
We recommend practical tests to ensure compatibility for each specific application.

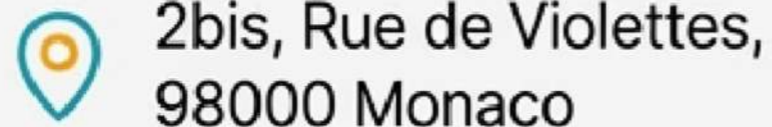
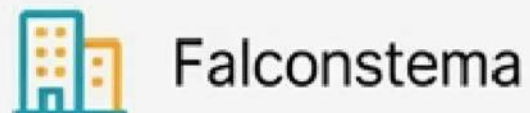

2bis, Rue de Violettes,
98000 Monaco



info@falconstema.mc



+377 99 90 56 35