

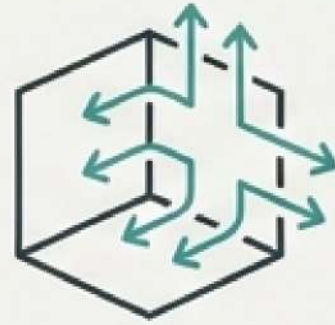

SUBERCONFORT DRY Mastic
A New Standard for Interior
Surface Performance

The Integrated Solution for Thermal, Acoustic,
and Moisture Control.

The Persistent Challenges of Interior Environments



Thermal Deficiencies

Cold spots, thermal bridges, and energy loss compromising comfort and efficiency.

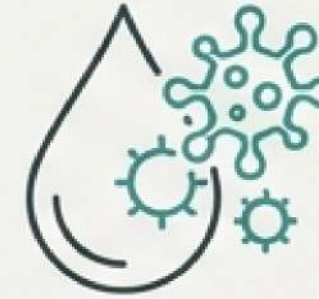

Moisture & Condensation

The root cause of mold, fungus, and long-term structural degradation.



Acoustic Intrusion

Impact noise that compromises the sound comfort and perceived quality of a space.

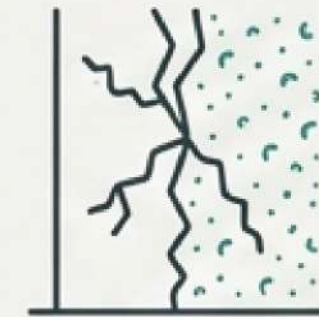

Surface Imperfections

Irregular substrates, from plaster to godelé, requiring extensive preparation and repair.

Introducing Suberconfort Dry

A powdered thermal mastic engineered to provide a definitive thermal and acoustic correction for interior surfaces.

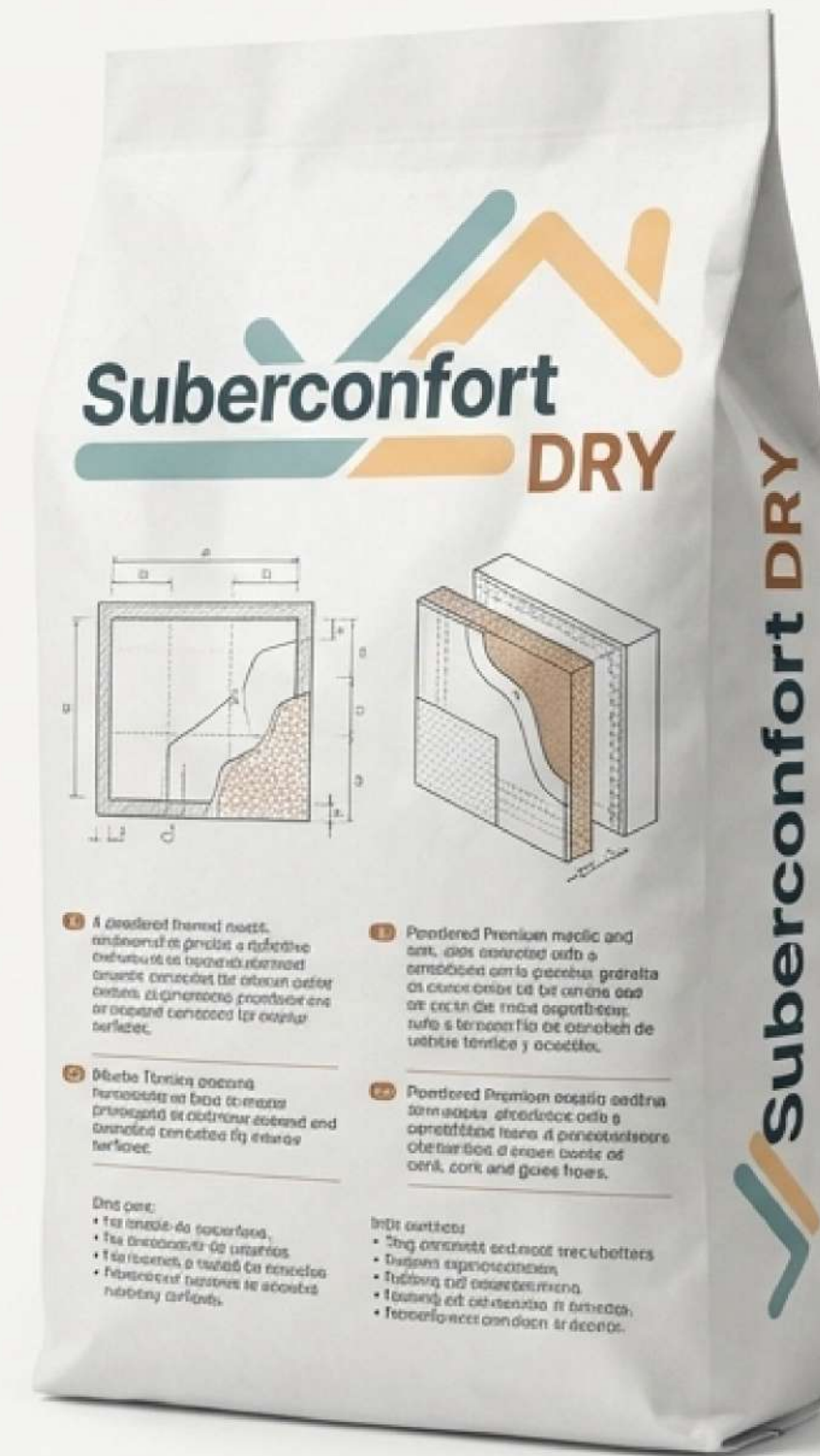

The Synergy of Natural and Engineered Materials

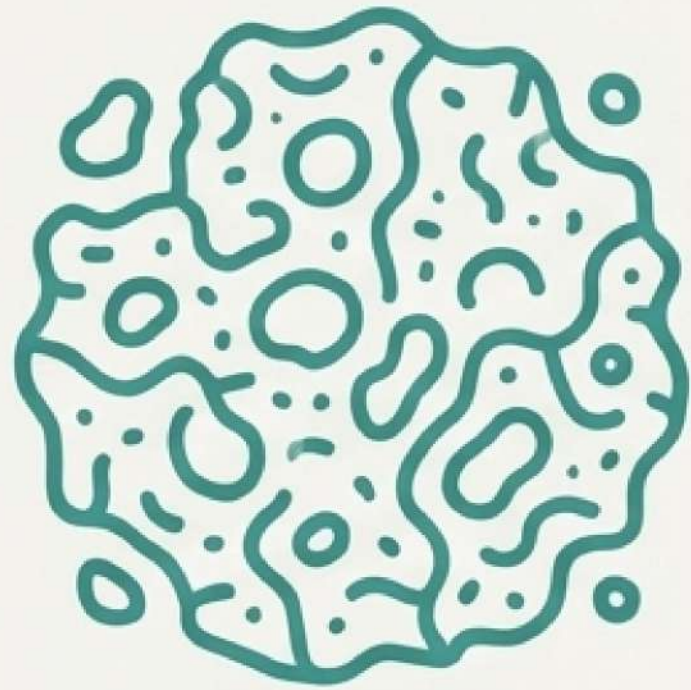

Natural Cork Granules

For superior thermal and acoustic insulation.



Glass Fibers

For structural integrity and crack resistance.



Cementitious Base

For exceptional adhesion and durability.

One Solution for Four Core Applications



Thermal Correction

Permanently addresses walls with poor insulation, eliminating thermal bridges.

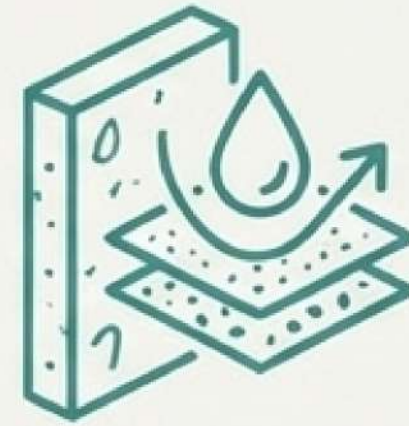

Moisture Management

Creates a breathable barrier, preventing condensation, mold, and fungus.

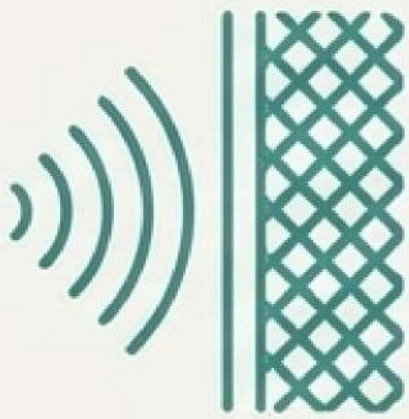

Acoustic Improvement

Effectively dampens impact noise, enhancing acoustic comfort.



Surface Renovation

Ideal for coating, smoothing, tiling, and jointing irregular surfaces like godelé.

Creating Warmer, Healthier Interior Environments

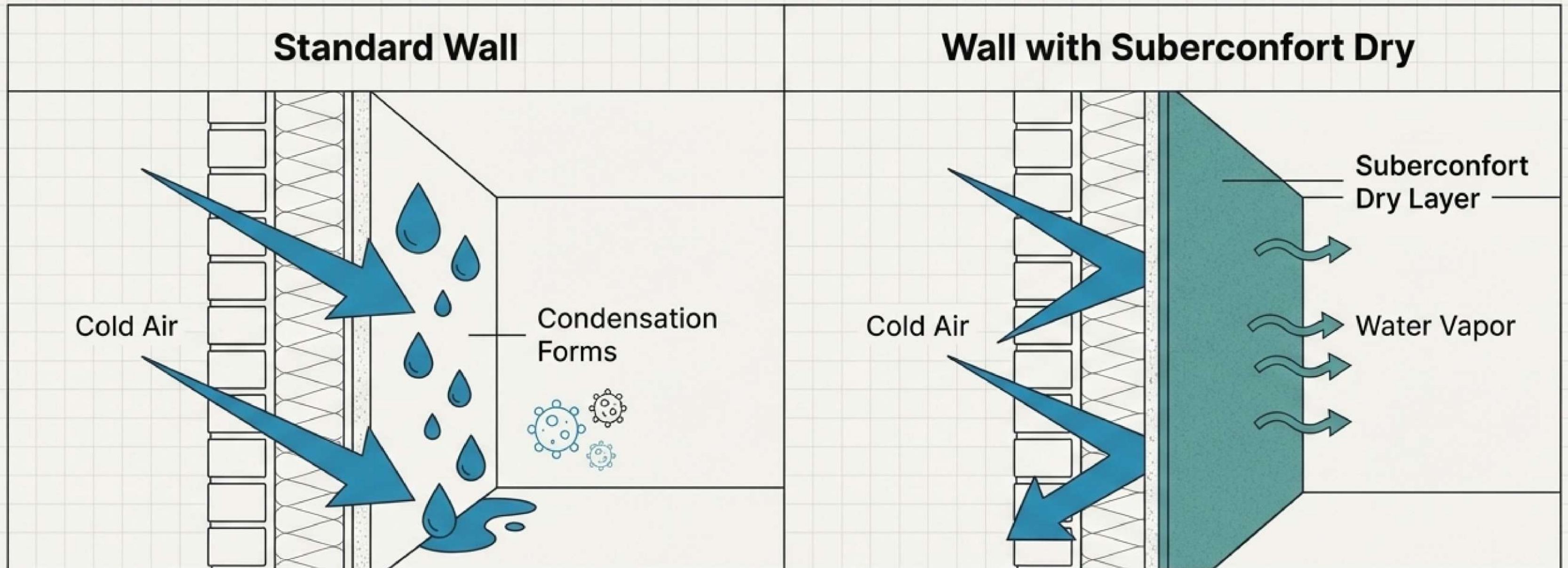

Breathable: Permeable to water vapor



Condensation-Free: Prevents the conditions that lead to mold and mildew

Engineered for Unmatched Adhesion

Suberconfort Dry is compatible with a wide range of common construction substrates:

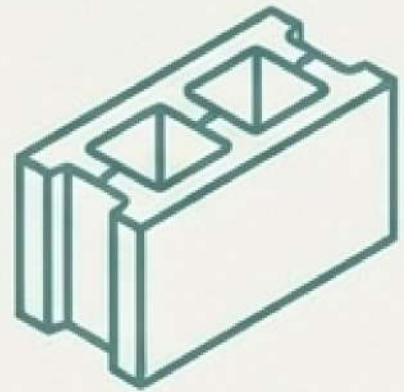

Concrete

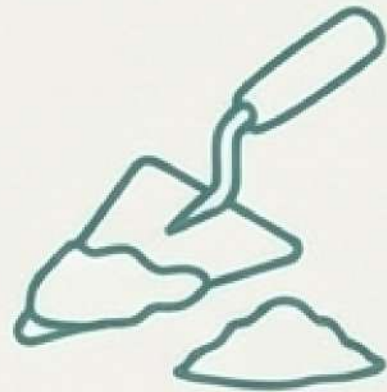

Cement

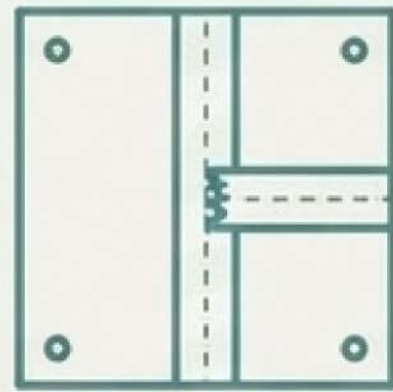

Plaster / BA13

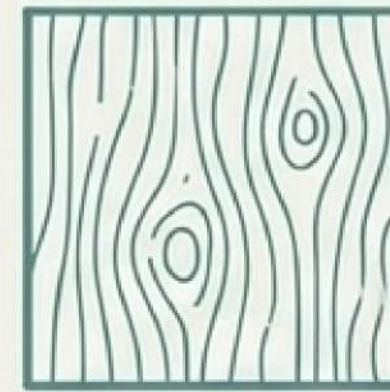

Wood



Galvanized Steel

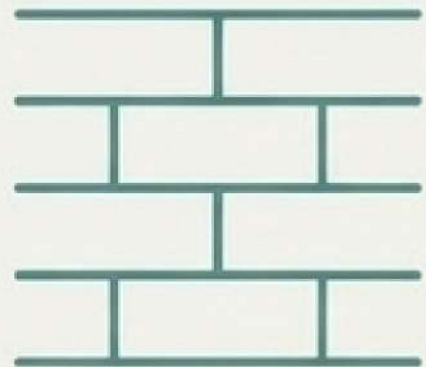

Mortar

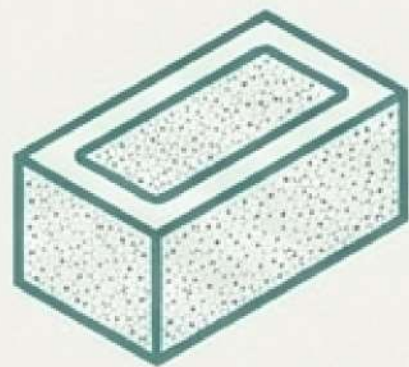

Ceramic Brick

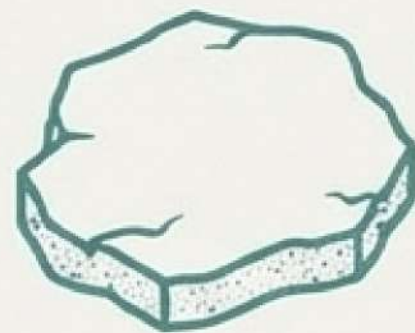

Natural Stone

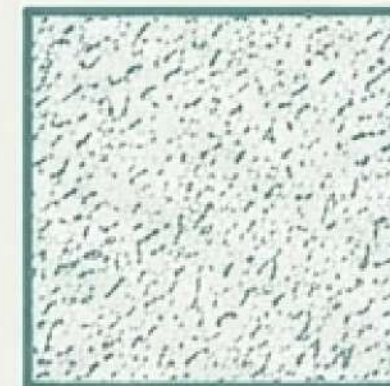

Single-layer Mortar

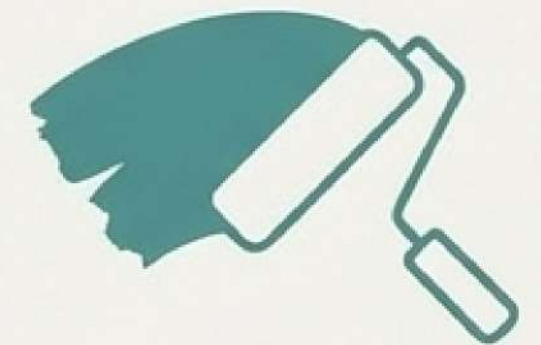

Existing Paint

Also suitable for application over existing paint and coatings in good condition.

Application Protocol Part 1: Preparation & Mixing

1. Substrate Preparation

- Ensure surface is clean, free of dust, and completely dry.
- Clean degraded media (e.g., loose paint, mold).
- For dusty/sandy surfaces, brush and apply Suber-Fix primer.
- For cracks, expand, clean, and prime with Suber-Fix before repair.



2. Mixing

Ratio:

Add 7 L of water per 8 kg bag.

Method:

Use a low-speed industrial whisk.

Time:

Mix for 3-5 minutes until a homogeneous dough is achieved.



Application Protocol Part 2: Application & Finishing

3. Application

- Slightly moisten the support before application.
- Apply in coats of 2-3 mm thickness.
- Allow 1-2 hours of drying time between layers (at 20°C).
- Clean tools with water immediately after use.



4. Finishing Options

Paint:

Compatible with aqueous (water-based) paints.

Varnish:

Can be varnished.

Tile:

Suitable as a base for tiling ('plated').

As-is:

Can be left as the applied finish.

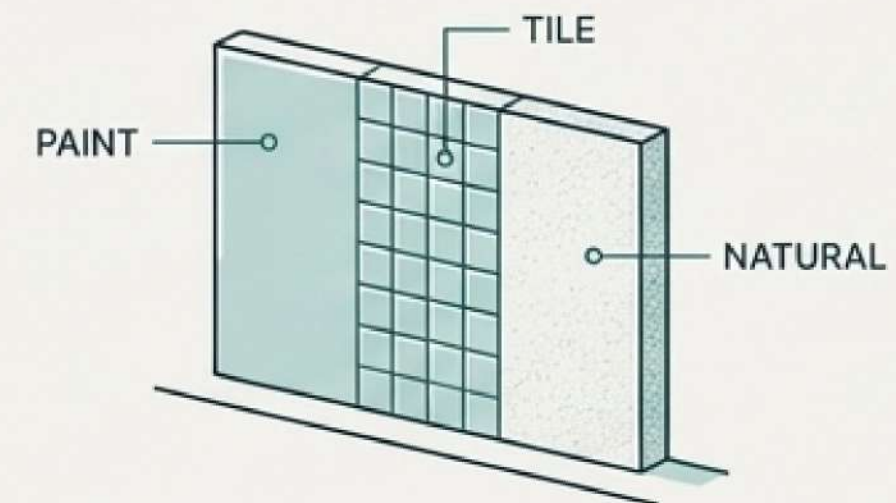

Technical Specifications at a Glance

Property	Value
Consumption	0.55 kg/m ² per mm of thickness
Density	0.50 kg/L (± 8%)
Appearance	Powder
Color	Brown
Packaging	8 kg Bag (approx. 16L volume)
Application Temp.	5°C to 45°C
Shelf Life	2 years from date of manufacture (in original sealed container)
Auto-ignition Temp.	260 °C

Professional Guidelines & Best Practices



- **Approved Applicators:** Suberlev products must be applied by applicators approved by the manufacturer to ensure guaranteed results.



- **Exterior Use:** Not recommended as a final exterior finish. Can be used as a base or intermediate layer.



- **Application Conditions:** Do not apply with risk of frost, in direct sunlight, or during strong wind or rain.



- **Storage:** Store in a cool place (5°C to 45°C), protected from moisture and direct sun exposure.

Certified Quality from Falcon Stema

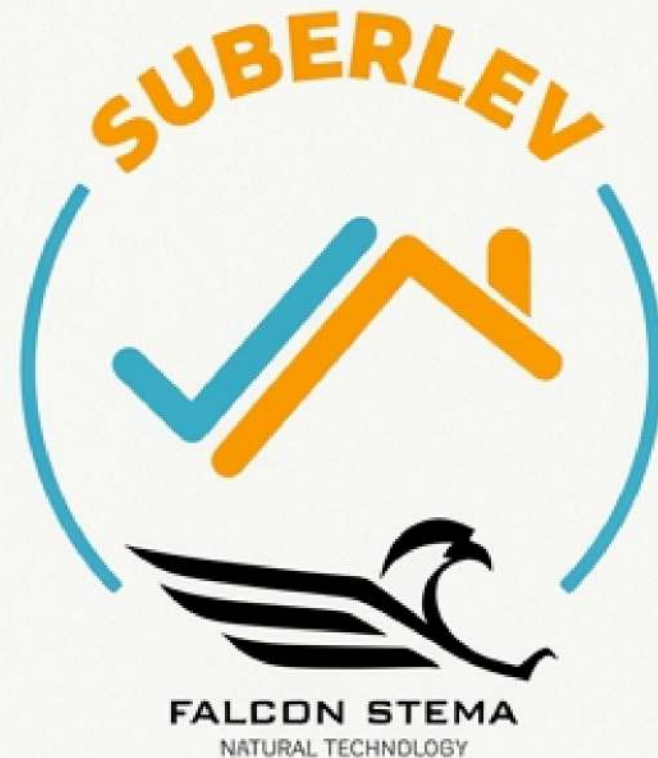

Suberconfort Dry is an innovation in thermal and acoustic insulation from Suberlev, a Falcon Stema brand.

Our formulations are based on extensive practical experience and laboratory testing to ensure optimal performance in every project.

Help Us Help You

Innovation in Protection.



The information provided is based on extensive practical experience and laboratory testing.
We recommend practical tests to ensure compatibility for each specific application.

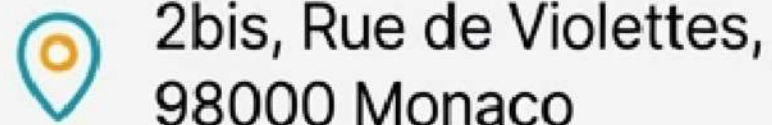
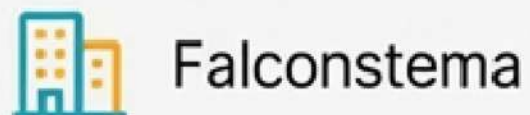

2bis, Rue de Violettes,
98000 Monaco



info@falconstema.mc



+377 99 90 56 35