

The Intelligent Evolution of Building Insulation

Suberlev Neopor: Advanced Thermal & Acoustic Insulation System

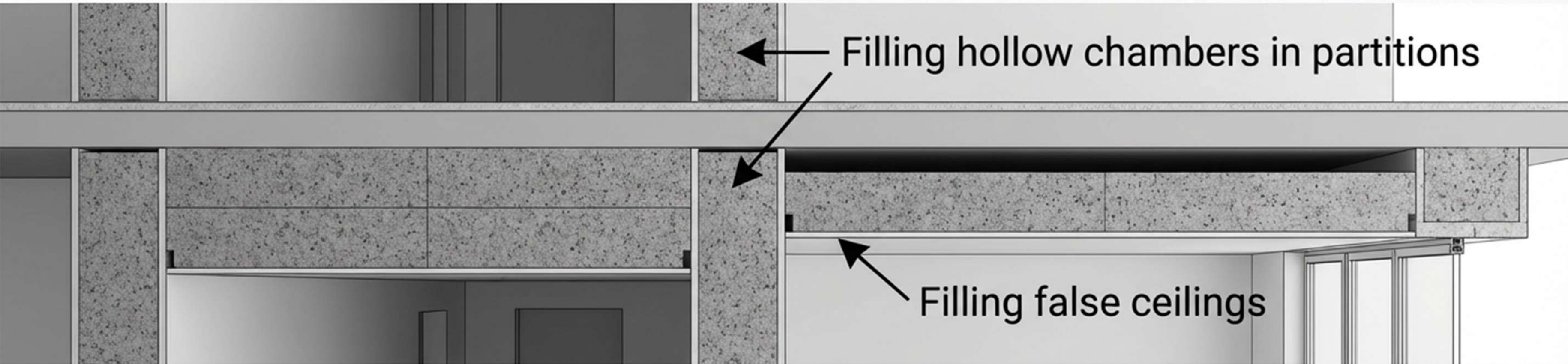

An innovative thermal insulation system made up of boards containing encapsulated graphite particles, giving them a characteristic gray color.



Meeting the Demands of Modern High-Performance Construction

- ✓ • Increasingly stringent energy efficiency standards.
- ✓ • The need for materials that ensure long-term building health and durability.
- ✓ • The requirement for insulation solutions that are both effective and practical to install across various project types.

Suberlev Neopor: Engineered Graphite-Infused Insulation

An innovative thermal insulation system made up of boards containing encapsulated graphite particles, giving them a characteristic gray color.

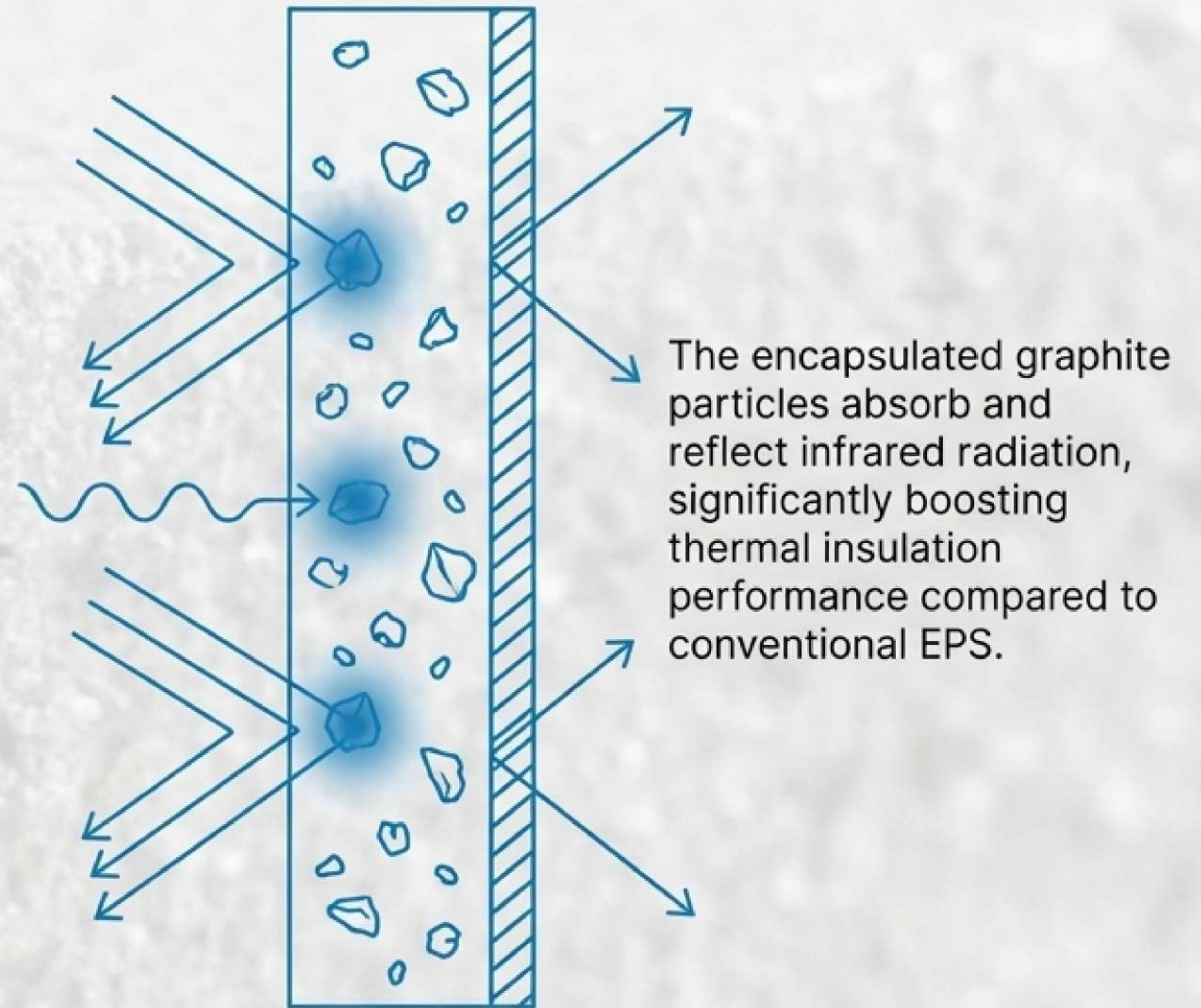

A Synthesis of Performance, Durability, and Practicality



High Thermal Performance

Advanced insulation to optimize energy efficiency.

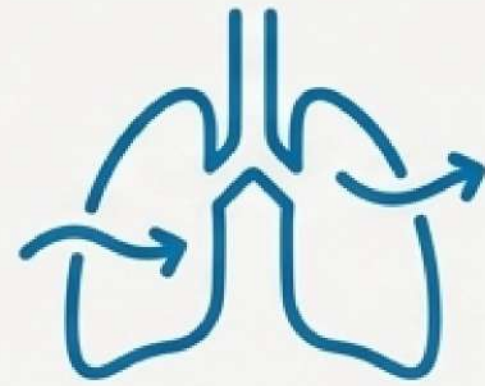

Breathable System

Allows natural vapor diffusion for healthier buildings.

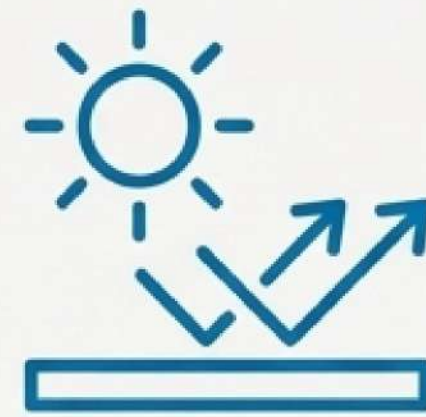

Infrared Reflectivity

Absorbs and reflects IR radiation for superior performance.

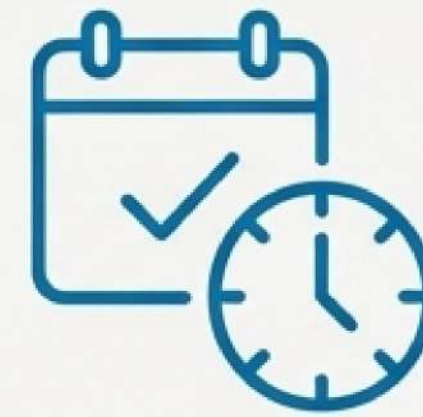

Long-Term Durability

High mechanical resistance ensures performance over time.



Lightweight & Versatile

Easy to handle, cut, and install on numerous substrates.

The ideal solution for thermal insulation projects in ETICS systems.

Engineered for Superior Thermal Performance

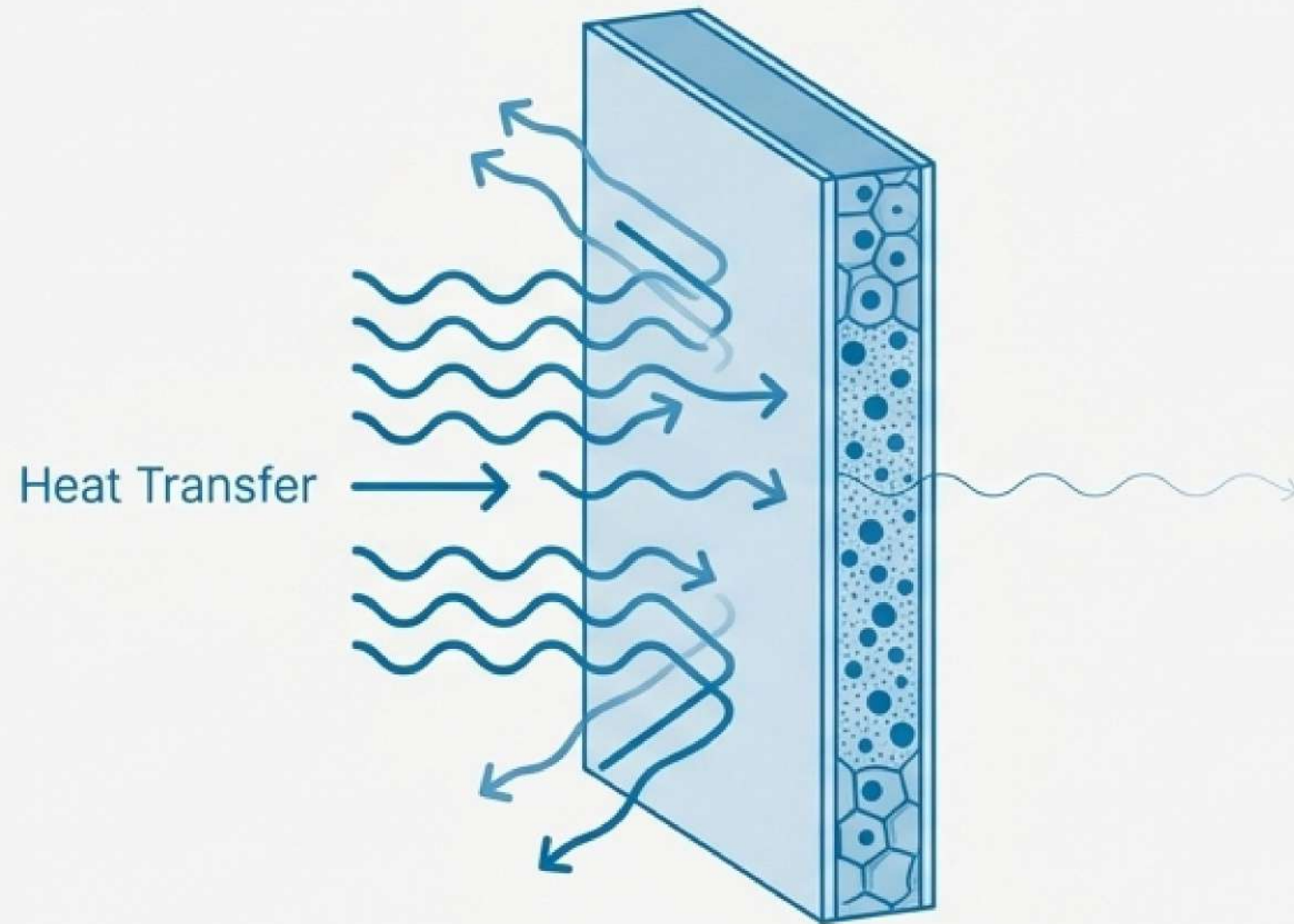

Suberlev Neopor's graphite-infused matrix significantly reduces heat transfer, optimizing energy efficiency and ensuring continuous insulation without thermal bridges in residential, commercial, or industrial buildings.

0.031 W/m.K

Certified according to EN 12667.

Scalable Thermal Resistance by Thickness

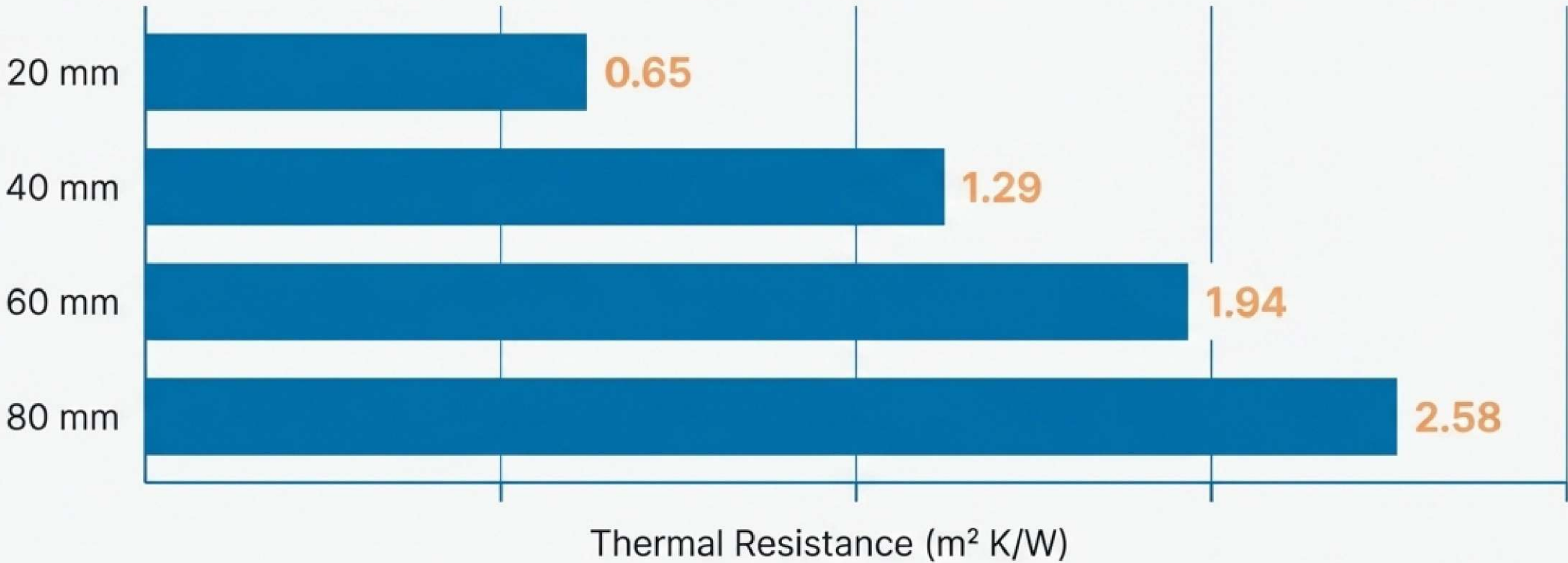

All values tested according to EN 12667.

Specify the precise level of thermal performance your project demands.

Built for Lasting Durability and On-Site Resilience

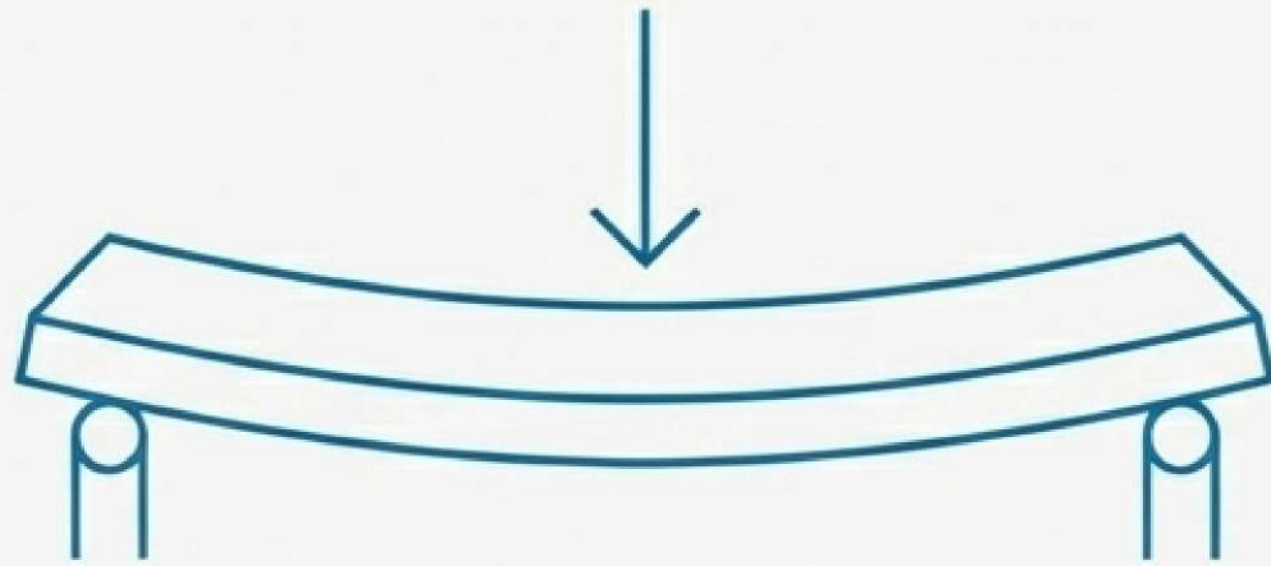

Bending Strength
 $\geq 100 \text{ kPa}$

EN 12089

Resists breakage during transport
and installation.

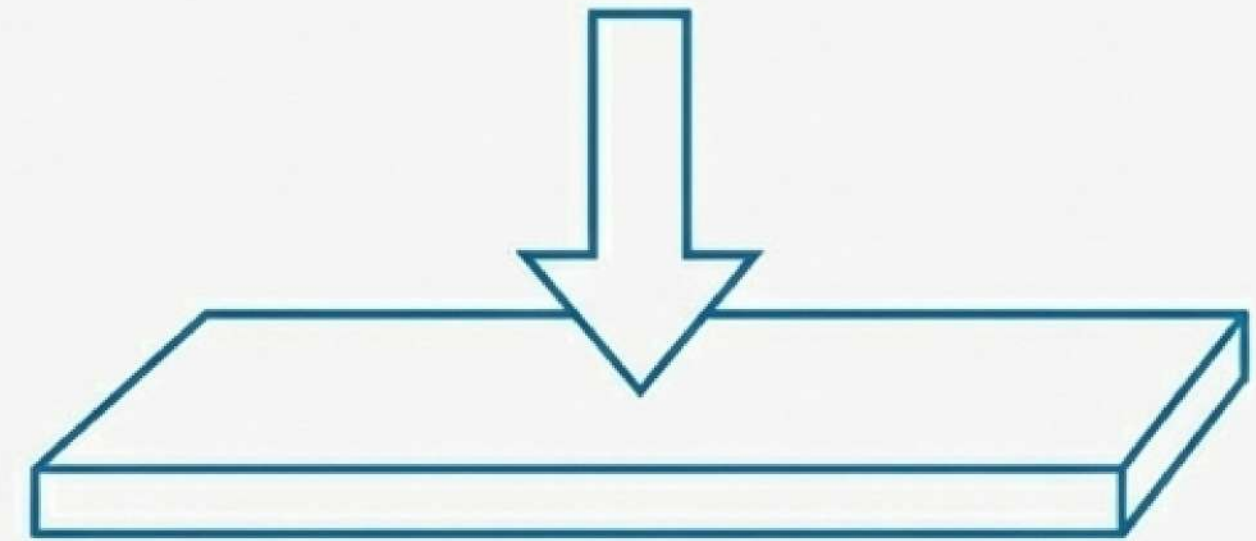

Compressive Strength
70 kPa

EN 826

Maintains structural integrity
under load.

Advanced Properties for Building Health and Safety



Breathability

Water Vapour Diffusion Resistance Factor (μ): **30 – 70**

EN 12086

Allows natural ventilation and prevents moisture buildup within the wall assembly, contributing to a healthier indoor environment.



Fire Resistance

Fire Resistance: **Euroclass E**

EN 13501-1

Meets established European standards for fire reaction performance in building materials.

Complete Technical Data Sheet

Property	Value / Range	Standard
Color	Grey Hard Plate	-
Board Dimensions	500 x 1000 mm	-
Thicknesses	20, 40, 60, 80 mm	-
Thermal Conductivity (λ)	0.031 W/m.K	EN 12667
Bending Strength	≥ 100 kPa	EN 12089
Compressive Strength	70 kPa	EN 826
Water Vapour Resistance (μ)	30 – 70	EN 12086
Fire Resistance	Euroclass E	EN 13501-1

CE marked. Tested according to EN 998-1 standards for optimal performance.

High Compatibility Across a Wide Range of Substrates

Suberlev Neopor is designed for application on flat surfaces and is compatible with common construction materials, including:

Concrete **Cement Mortar**

Plaster & Plasterboard Fiber Cement **Wood**

Galvanized Steel **Ceramic Brick** Natural Stone

Expanded Polystyrene (EPS)

Extruded Polystyrene (XPS)

One-coat mortar PVC ...and more.

A Clear and Efficient 5-Step Application Process



SUBERLEV products must be applied by applicators approved by the manufacturer.

Step 1 & 2: Substrate Preparation & Board Placement

Surface Preparation

Critical Checks: Surface must be perfectly clean, dry, and free of dust, grease, or paint.

Key Warning: Avoid high-pressure water or chemicals to prevent internal humidity.

Repairs: Use Thermal Mastic to repair any cracks or unevenness.

Adhesive Application: Apply Thermal Mastic with a notched trowel at a coverage rate of 2.2 kg/m².

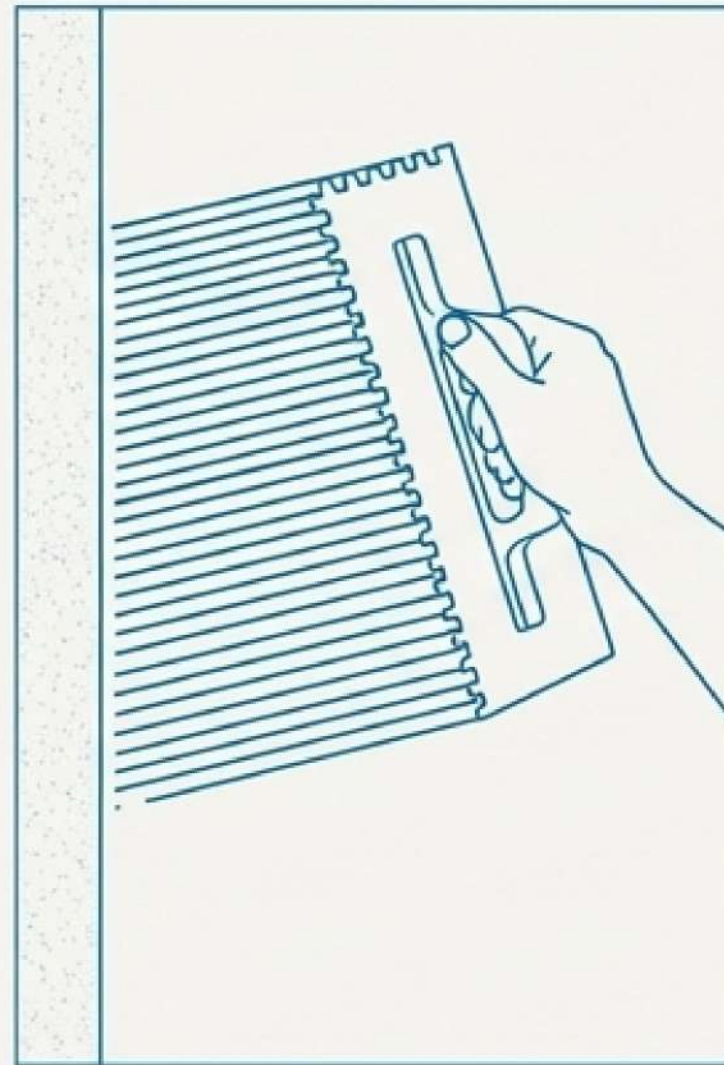

Placing the Boards

Method: Install boards from the bottom of the wall upwards.

Pattern: Use a staggered (brick-bond) pattern to ensure joint offset and system integrity.

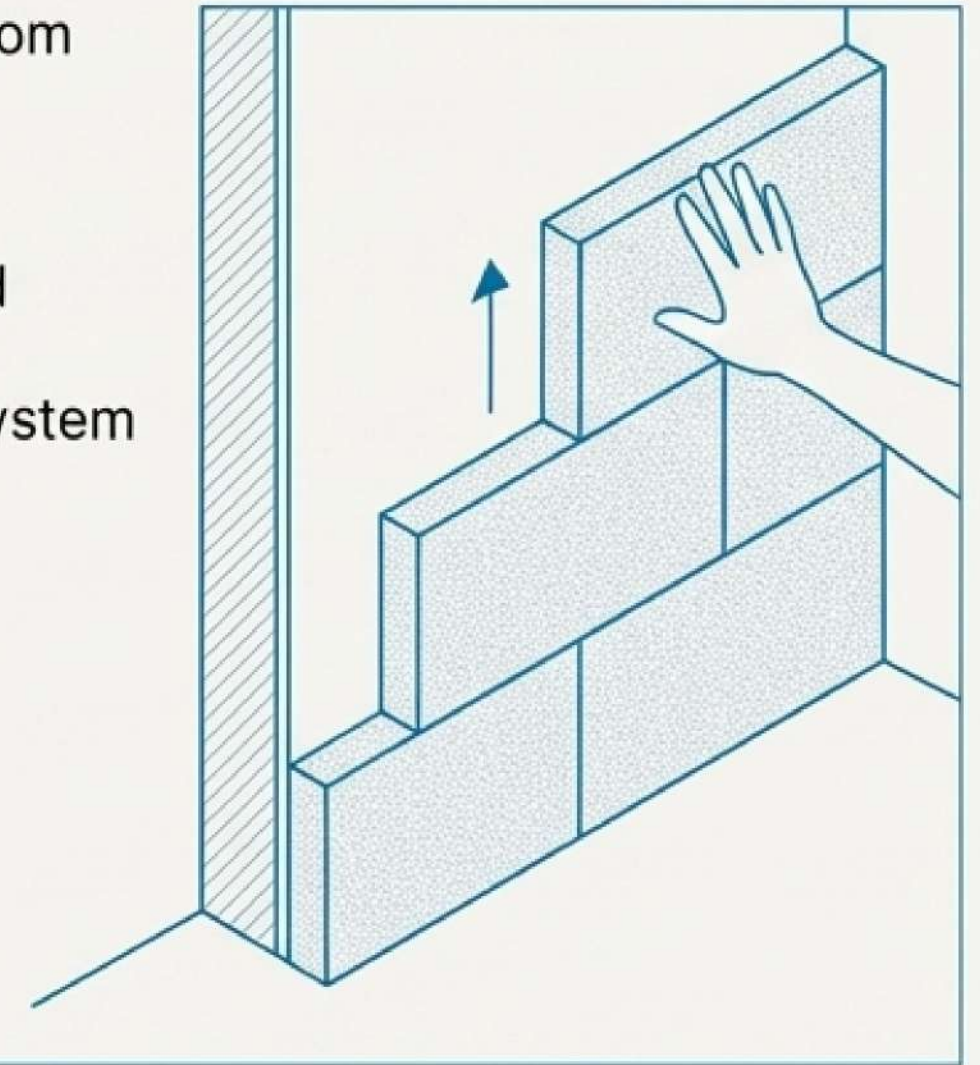

Step 3-5: Fixing, Coating, and Final Finish

Section 3: Fixing the Boards

- **Anchoring:** Securely anchor all boards with mechanical fixing pins.
- **Sealing:** Use Thermal Filler to seal all joints between boards and to cover any irregularities caused by the fixing pins.

Section 4: Applying Mastic Coat

- **Process:** Apply 1 or 2 additional layers of Thermal Filler to fully coat the boards.
- **Purpose:** Provides uniformity, impact resistance, and a prepared surface for the final finish.

Section 5: Final Finish

- **Action:** Once the system is fully dry, apply the chosen finishing material (e.g., render, paint).

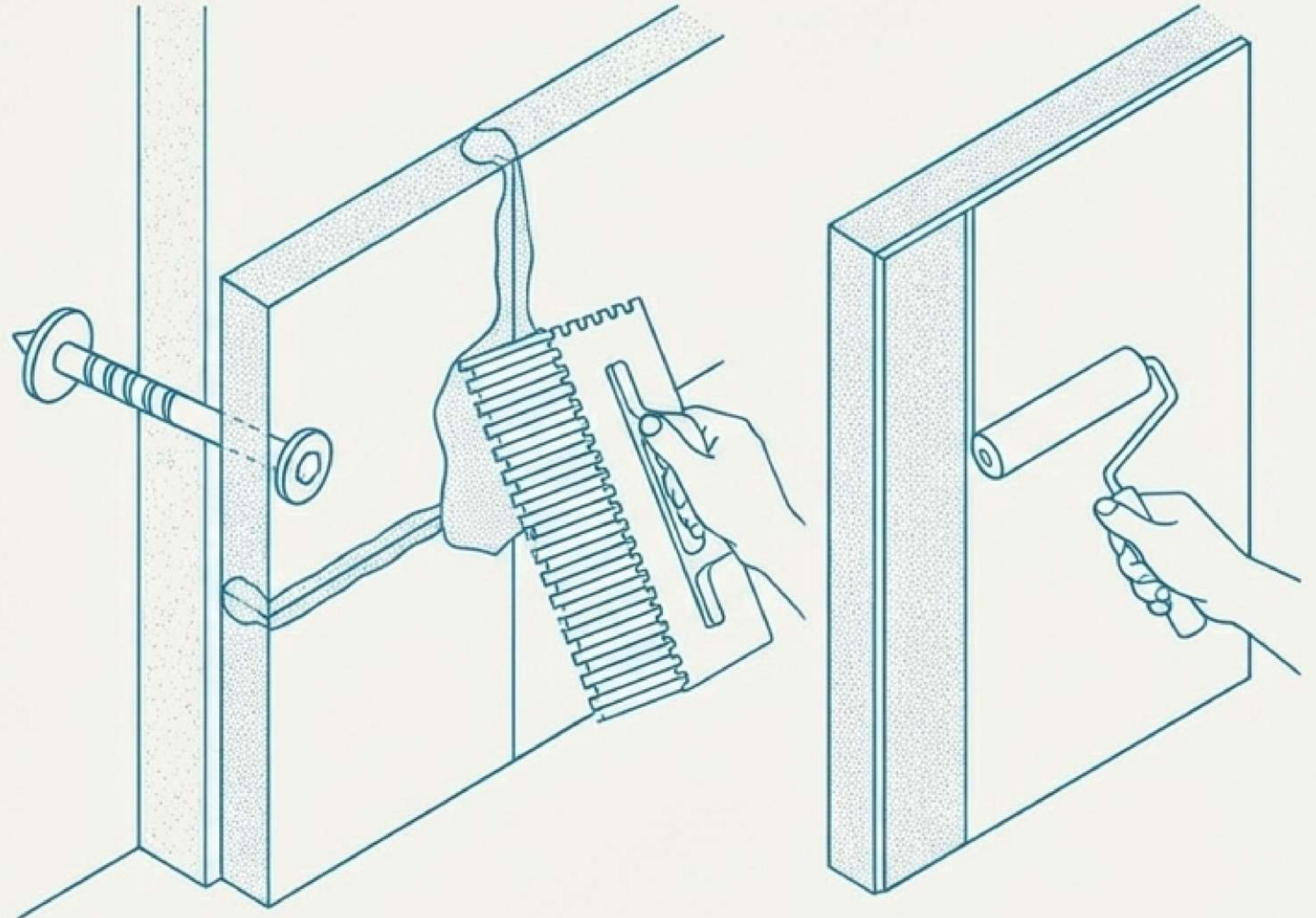

Product Dimensions and Packaging Specifications

Standard Board Size: 500 x 1000 mm

Thickness	Units per Pack
20 mm	40 units
40 mm	20 units
60 mm	12 units
80 mm	10 units

Storage Note

Keep the product in a cool, dry place.
Keep out of reach of children.



Help Us Help You

Innovation in Protection.



The information provided is based on extensive practical experience and laboratory testing.
We recommend practical tests to ensure compatibility for each specific application.

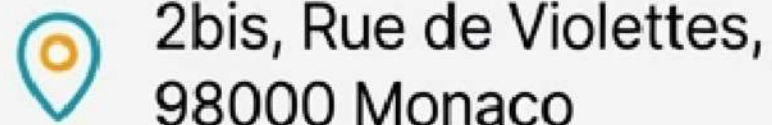
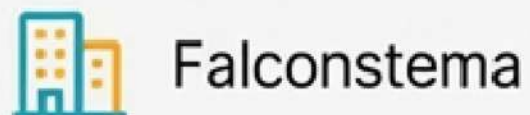

2bis, Rue de Violettes,
98000 Monaco



info@falconstema.mc



+377 99 90 56 35